

Product Catalog

iFlow™ Droplet & Single-Cell

Microfluidic Systems & Solutions



iFlow™ Droplet System -Touchscreen Version

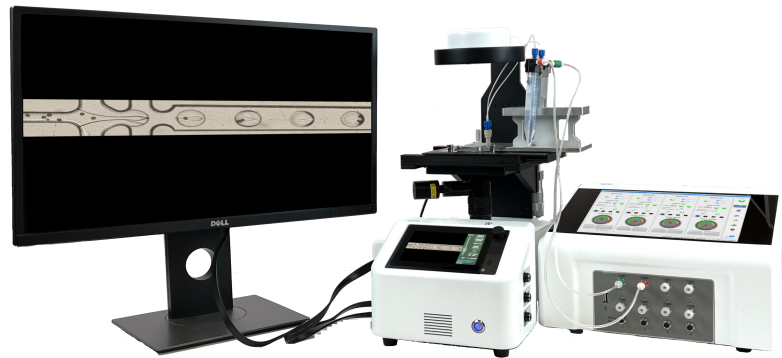

Microfluidic droplet generation allows greater control over size and uniformity than conventional batch production.

PreciGenome's droplet generation package provides a convenient open platform compatible with a wide range of chip designs. It may also be configured for either small volume production (<0.5 ml) or large volume (1.5 ml - 1 L). Single and double emulsion configurations are both available, and the iFlow Touch pressure controller provides a convenient AIO control and display unit.

Key Benefits

High Performance & Efficiency



- Tunable size (chip dependent)
- Uniform production
- Poisson encapsulation

Open Platform



- Reagents
- Microfluidic chips

Scalable Throughput



- Direct plug reservoirs: <0.5ml
- Reservoir kits: 1.5 ml - 1 L

Simple Operation



- Easy setup
- Compact size
- Intuitive UI w/ touchscreen

Cost Effective



- Affordable configuration
- Low cost consumables

Single Emulsion Pack

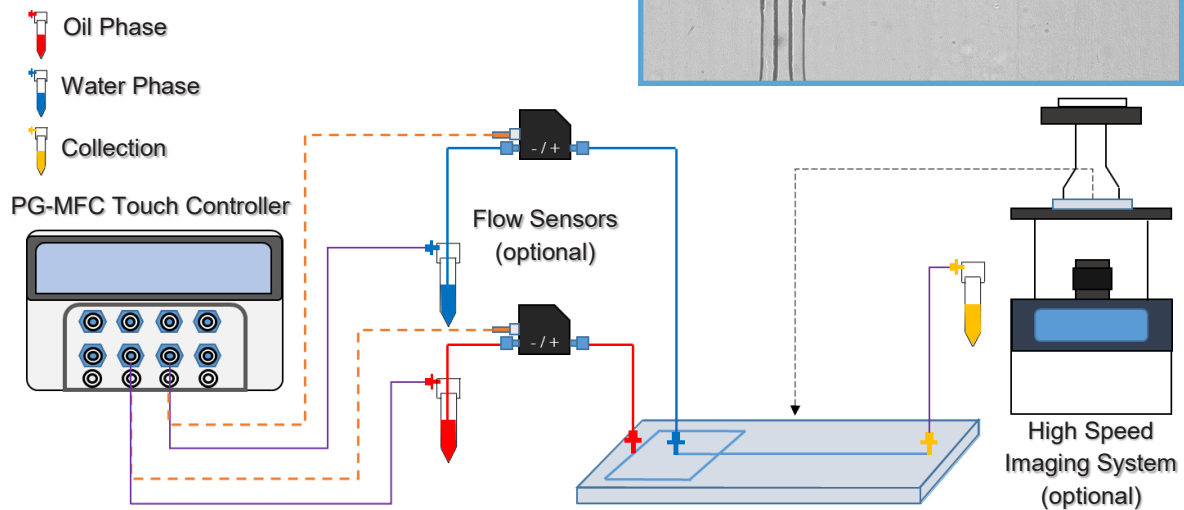

In single emulsion, one dispersed phase forms uniform droplets within the continuous phase. This setup is for water-in-oil emulsion. Oil-in-water emulsion would switch the two phases' positions.

Double Emulsion Pack

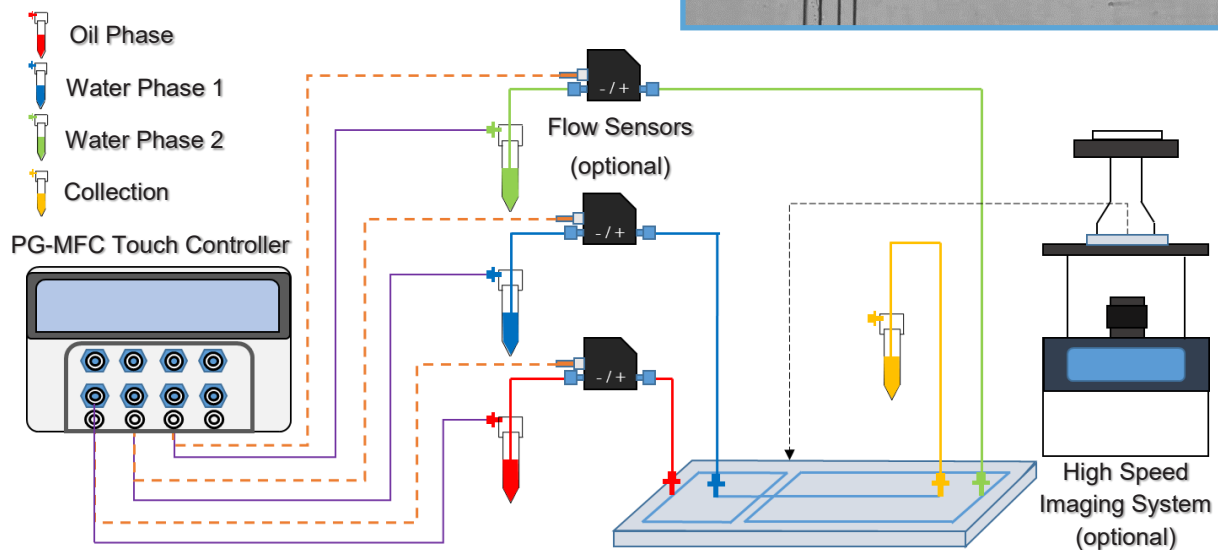



In double emulsion, an additional continuous phase encapsulates the initial droplets formed in the first emulsion event. This setup is for water-in-oil-in-water emulsion. Switching water phase 2 and the oil phase would result in a three-inlet single emulsion.

iFlow™ Droplet System - Light Version



PreciGenome's droplet generation package is also available with an iFlow Light pressure controller. This setup is more affordable and compact. External pressure source and display unit are required for full functionality.

Diagram for Single Emulsion

-  Oil Phase
-  Water Phase
-  Collection

PG-MFC
Light Controller + Pump

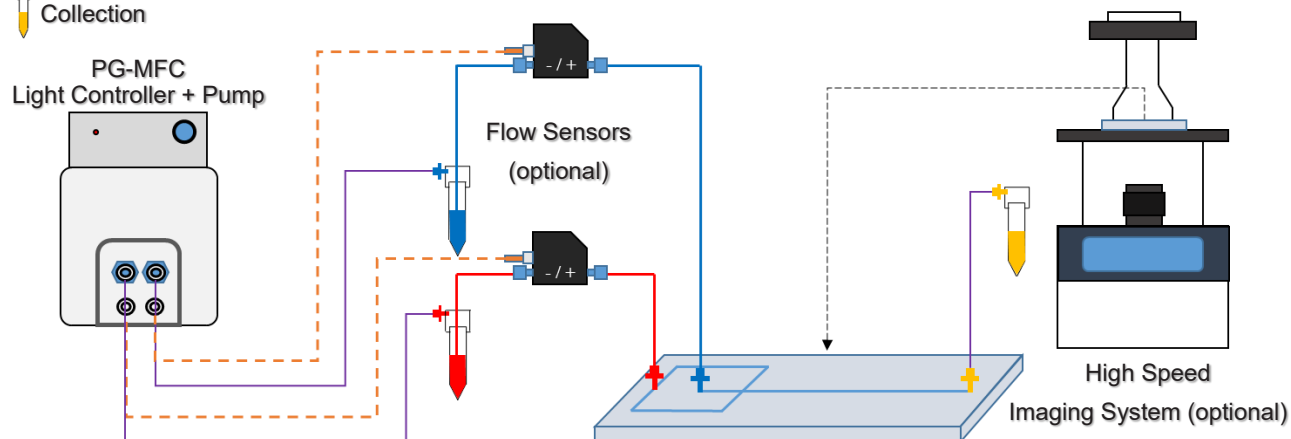

Though the pressure source is different for this package, the principles of droplet generation are the same regardless of pressure controller used. With the right chip and setup, the iFlow Light may be configured for single emulsion shown above, or double emulsion (not shown.)

System Contents

PG-MFC-LT-2CH light pressure controller

2x reservoir kits (1.5, 15, 50, 100, or 1000 ml)

2x reservoir tube racks (15 or 50 ml)

2x droplet generation chips (assorted models)

PG-LFS flow sensor (assorted full scale, optional)

Tubings & fittings

PG-HSV high speed imaging system (optional)

PG-MP1 mini vacuum/air pump (optional)

Working Principle

The system requires two or more unmixable liquid phases, referred to as the dispersed phase, sometimes called the droplet phase, and the continuous phase. The schematic below illustrates the device with junction in focused-flow geometry designed for droplet generation.

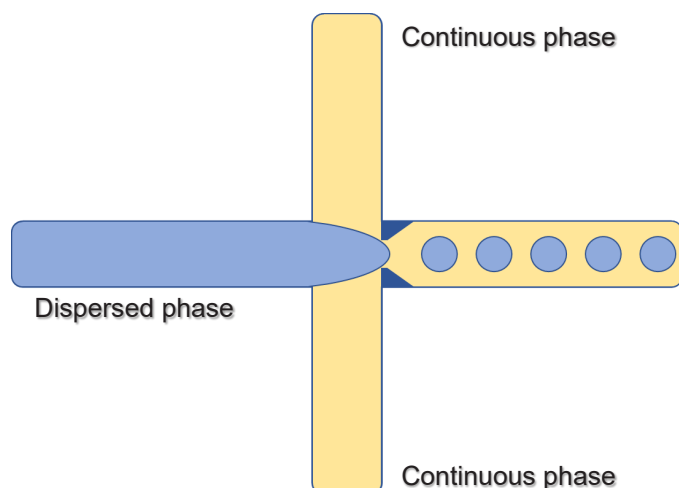

Schematic illustration of enlarged junction, controlled break-up droplet at the orifice. The flow through the orifice enables a controlled droplets break-up, which is required for yielding monodisperse micro-emulsions.

Microfluidic Droplet Generator Chips

PreciGenome offers a variety of droplet generator chips in different materials to meet most of our customers' application requirements.

Two types of materials, including polymers (PC, COC, COP etc.) and glass, are commonly used to fabricate microfluidic chips. Material of the chip is selected depending on the application requirements, including chip design, types of solvent or reagent used for experiment, needs of the application, budget, and fabrication time etc. Usually, for research purposes the materials for the chip fabrication generally prioritize performance of the device. For mass production of a products, the factors of production cost, reliability and ease of use are considered first.

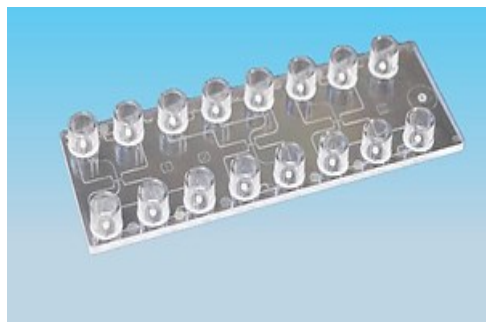

- *Droplet-based PCR*
- *DNA/RNA sequencing*
- *Drug delivery*
- *Protein crystallization*
- *Cell culture*
- *Chemical synthesis*
- *Microparticle synthesis*
- *Gel particle synthesis*

Droplet-based PCR

Digital PCR system as a new generations of Polymerase Chain Reaction (PCR) system has been an important tool in genomics and biological fields. Droplet PCR operates by assembling ingredients, forming droplets, combining droplets, thermocycling, and then processing results by using water-in-oil systems.

DNA/RNA sequencing

Droplet-based microfluidic systems have been used for DNA/RNA sequencing

Drug Delivery

Droplet microfluidics enables useful platforms for drug delivery vehicles and drug molecules as novel functional materials. Because of uniform size, monodisperse size distribution, and desired properties, droplet microfluidics demonstrates promising potential for production of complex drug systems.

Protein crystallization

Droplet microfluidics technology has been used for investigating the conditions necessary for protein crystallization.

Cell culture

Droplets are able to be used as incubators for single cells. Due to the high throughput, incubation in up to millions of droplets offers powerful capacity of characterizing cell population based on cells' kinetic behavior such as protein secretion, enzyme activity, etc.

Chemical synthesis

Droplet-based microfluidics has become an important method for chemical synthesis. Droplets are able to act as individual reactions, which are free from contamination from outside.

Microparticle synthesis

Advanced particles and particle-based materials, such as polymer particles, microcapsules, nanocrystals, and photonic crystal beads can be synthesized by the droplet generation system. The system is also able to synthesize microparticles/nanoparticles, like PLGA microparticles, colloidal CdS and CdS/CdSe core-shell nanoparticles.



Gel Particle Synthesis

In the last decade, the gel particles (hydrogels, microgels, and nanogels) has been an area of interest for many researchers and industries. Because of high throughput, mono-dispersity of particles, and low cost, droplet-based microfluidic systems have been widely used.



Droplet Size & Frequency Tuning

With its user-friendly interface and tunable pneumatic pumps, the iFlow pressure controller allows fine control over pressure ratios to achieve a wide range of droplet sizes and production rates with high consistency between different scales of production.



Selected data is for microfluidic chips with 38 μm nozzle width in a single emulsion configuration (three-inlet is capable of double emulsion, not shown.)

Water 2 psi		75.3 μm
Oil 2 psi		950 hz
Water 3 psi		65.7 μm
Oil 4 psi		1488 hz
Water 4 psi		58.8 μm
Oil 6 psi		2078 hz



Two-Inlet Chip (15 ml Reservoir Kits)

Water 2 psi		76.1 μm
Oil 2 psi		858 hz
Water 3 psi		64.1 μm
Oil 4 psi		1169 hz
Water 4 psi		55.5 μm
Oil 6 psi		2200 hz

Two-Inlet Chip (500 μl Chip Tanks)

Water 2 psi		86.5 μm
Oil 3 psi		465 hz
Water 3 psi		73.5 μm
Oil 6 psi		1488 hz
Water 4 psi		63.9 μm
Oil 9 psi		2976 hz

Three-Inlet Chip (15 ml Reservoir Kits)

Water 2 psi		87.4 μm
Oil 3 psi		651 hz
Water 3 psi		73.5 μm
Oil 6 psi		2425 hz
Water 4 psi		51.3 μm
Oil 9 psi		9954 hz

Three-Inlet Chip (500 μl Chip Tanks)

Oil:Water Pressure Ratio vs. Droplet Size

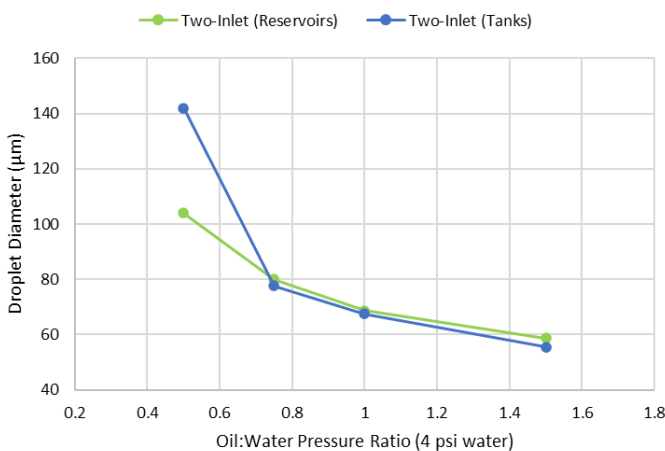

Oil:Water Pressure Ratio vs. Droplet Size

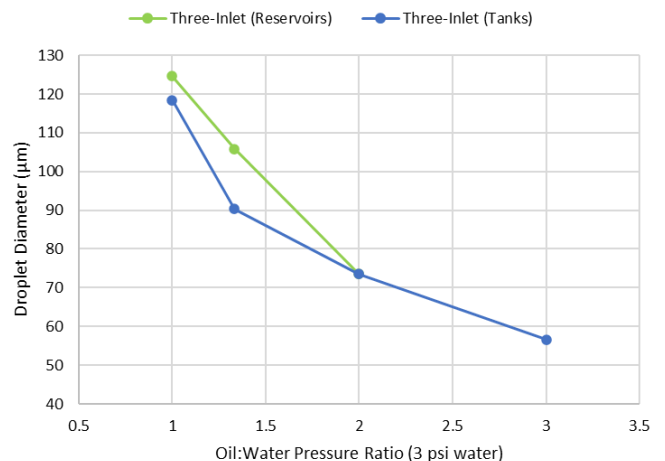



Product Model	iFlow Touch with imaging	iFlow Touch	iFlow Light	Custom Design
Part Number	PG-DG-8-HSV	PG-DG-8	PG-DG-LT2	PG-DG-X
Single Emulsion	✓	✓	✓	✓
Double Emulsion (o/w/o or w/o/w)	✓	✓	✗	✓
Droplet Size	20-200um	20-200um	50-150um	Custom Design
Monodispersity	0.1 - 5%	0.1- 5%	0.1 - 5%	0.1 - 5%
Generation rate	Up to 5kHz	Up to 5kHz	Up to 5kHz	Up to 5kHz
Chip Material	COC/COP/PC/Glass	COC/COP/PC/Glass	COC/COP/PC/Glass	COC/COP/PDMS/ Glass
Wetted materials	PTFE/ PEEK/PP/PC	PTFE/ PEEK/PP/PC	PTFE/ PEEK/PP/PC	Custom Design
Independent Channels of Flow/ Pressure	4	4	2	>=2
Small volume pack with 0.02 to 0.5mL throughput (optional)	✓	✓	✗	✓
Large volume pack with >0.5ml throughput (optional)	✓	✓	✓	✓
Integrated Software & Computer	✓	✓	✗	✓
Integrated Pumps	✓	✓	✗	✓
Liquid Flow Sensor (optional)	✓	✓	✓	✓
High-speed Imaging (optional)	✓	✓	✓	✓
Frame Rate of Imaging	1280x1024 @ >1050 fps, up to 38000fps at lower resolution.			
Installation, Training,	✓	✓	✓	✓
Custom Design/ OEM	✓	✓	✓	✓

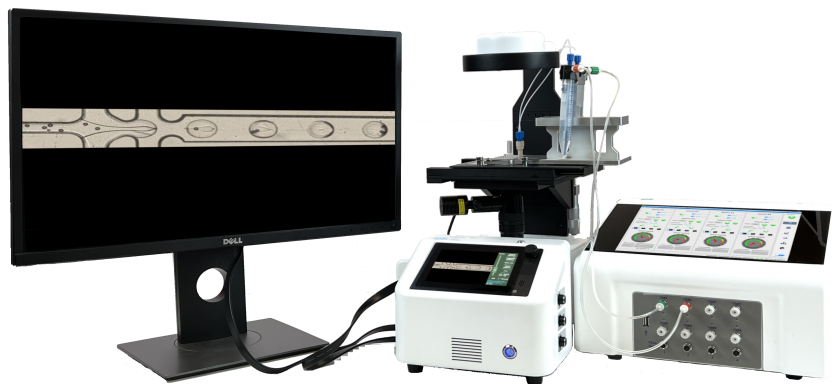

Key Benefits

Open Platform



Cost Effective



Portable Design



**Easy Operation w/
Touchscreen**



**Flexible Setup,
Programmable**



**Custom Design
& OEM**



Applications

- Single cell isolation & PCR amplification
- Single cell antibody discovery
- Single cell analysis
- Cell line development
- DNA/RNA sequencing library
- Biopharmaceutical discovery
- Drug-resistance studies
- Double emulsion
- Enzyme evolution
- Synthetic biology

Catalog #	Name
PG-SC-8-HSV	System w. iFlow Touch™ controller and highspeed imaging
PG-SC-8	System w. iFlow Touch™ controller

Encapsulation vs. Poisson Distribution

Using 10 μm polystyrene beads as a model for mammal cells, droplet encapsulation follows the Poisson distribution. *Data shown is for 55-60 μm droplets; expected value is with one-third of initial bead concentration (chip design dependent.)*

Single Encapsulation - 10 μm beads

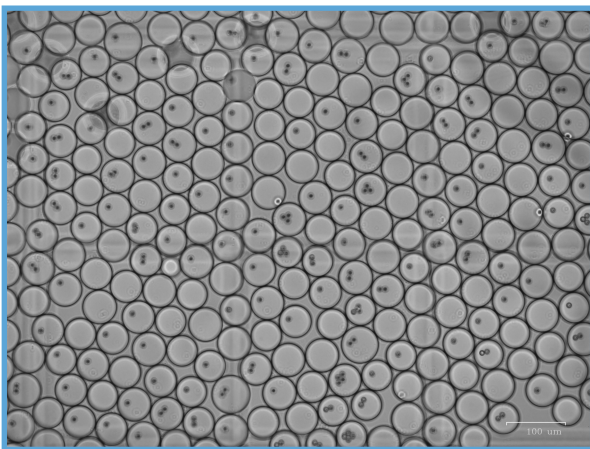

Single Encapsulation - Single Emulsion

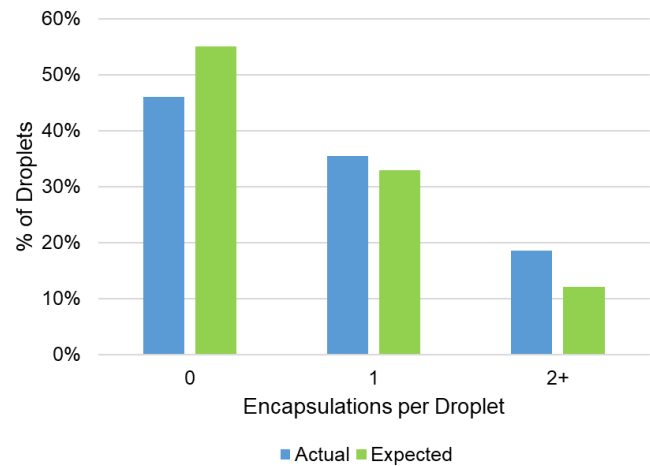

Beads Concentration vs. Encapsulation Rates

The Poisson distribution also holds for other bead concentrations. As bead concentration decreases, a greater percentage of droplets have no or one encapsulation events. *Data shown is for 55-60 μm droplets; expected value is one-third of initial bead concentration (chip design dependent.)*

Initial Bead Concentration (beads/ml)	% 0 Encapsulations		% 1 Encapsulations		% 2+ Encapsulations	
	Actual	Expected	Actual	Expected	Actual	Expected
7,470,000	80.3	75.5	18.1	21.2	1.6	3.3
12,900,000	69.4	68.8	24.5	25.7	6.1	5.5
20,580,000	46.1	55.0	35.4	32.9	18.5	12.1

Double Emulsion Encapsulation

Droplet encapsulation also follows the Poisson distribution in double emulsion systems. *Data shown is for 30 μm inner shell; expected value is with one-half of initial bead concentration (chip design dependent.)*

Single Encapsulation - 10 μm beads

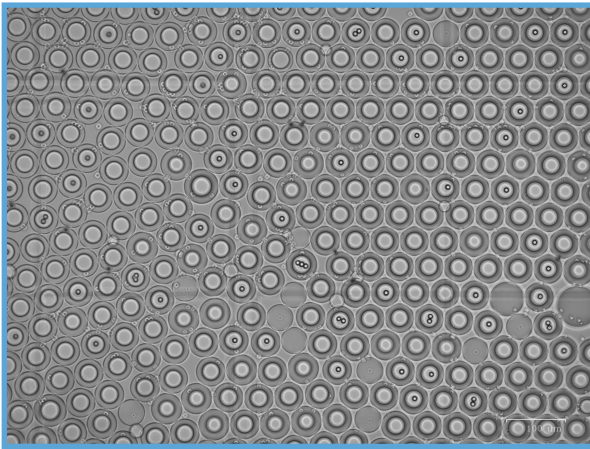

Single Encapsulation - Double Emulsion

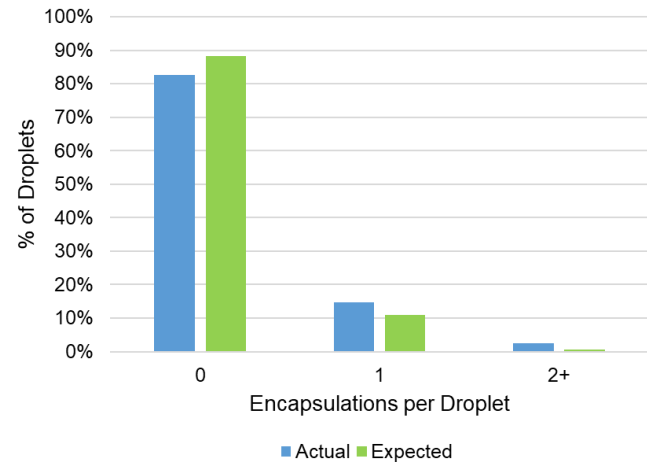

Initial Bead Concentration (beads/ml)	% 0 Encapsulations		% 1 Encapsulations		% 2+ Encapsulations	
	Actual	Expected	Actual	Expected	Actual	Expected
17,610,000	82.6	88.3	14.8	11.0	2.6	0.7

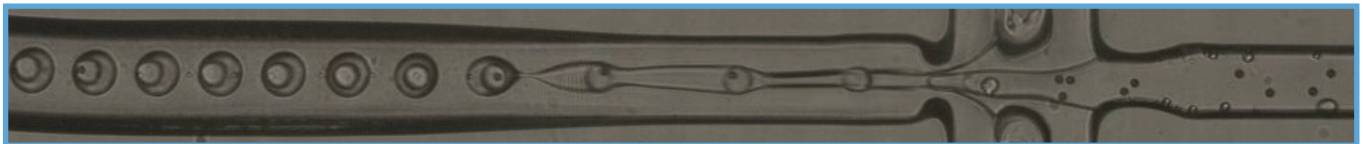

Surfactants and/or stabilizing agents are needed to maintain stable double emulsions, and pressure tuning can adjust droplet size. Factors such as presence of cells or inorganic salts may affect surfactant choice. *The following surfactant mixes were used for each phase:*

Phase	Solvent	Surfactant
Inner Water	DI H ₂ O OR	0.5-1% TWEEN-20 OR
	1x PBS	0.5-2% BSA
Oil	HFE 7500	2.2% Krytox 157
Outer Water	DI H ₂ O OR	1-3% Triton X-100
	1x PBS	

Application: Drop-Seq

Working Principle

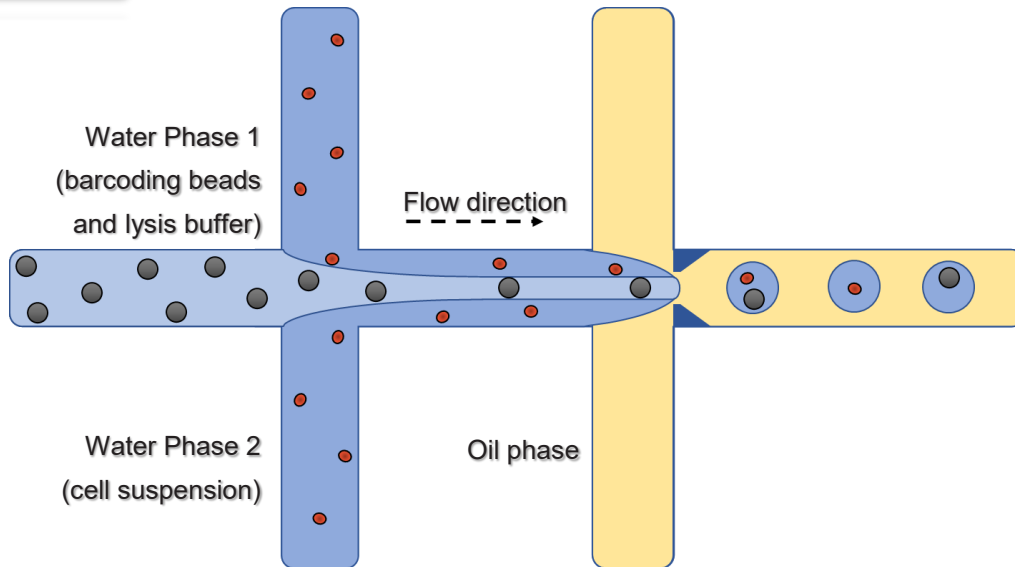

In Drop-Seq, the microfluidic chip allows two water phases to mix before being dispersed in the oil phase. This allows barcoding beads and cells to be captured together in droplets.

System Diagram

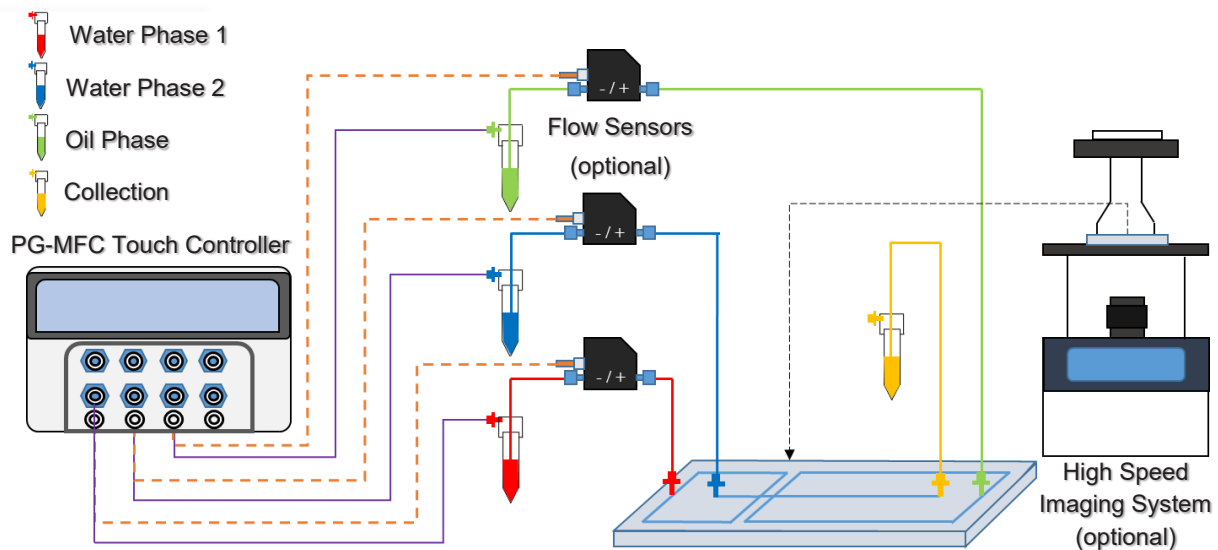

Drop-Seq Introduction

An expansion of single cell encapsulation, Drop-Seq uses droplets to pair single cells with single barcoding microparticles. The resulting droplets serve as miniature independent reaction chambers for cell lysis and RNA hybridization, after which the products may be collected and sequenced to generate a library of thousands of single-cell transcriptomes.

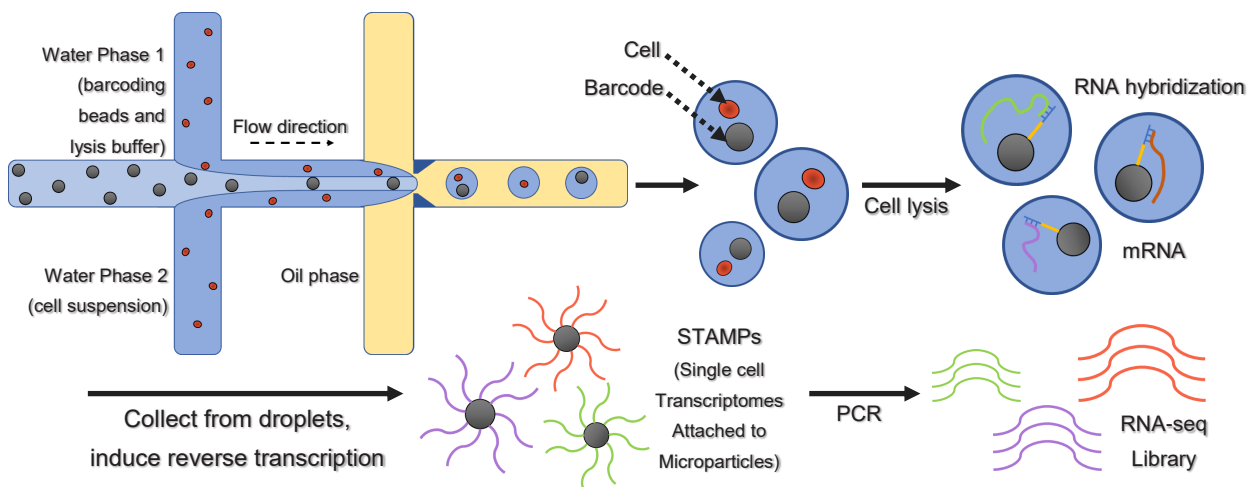

Drop-Seq Encapsulation

Drop-Seq Model - 10 and 20 μm beads

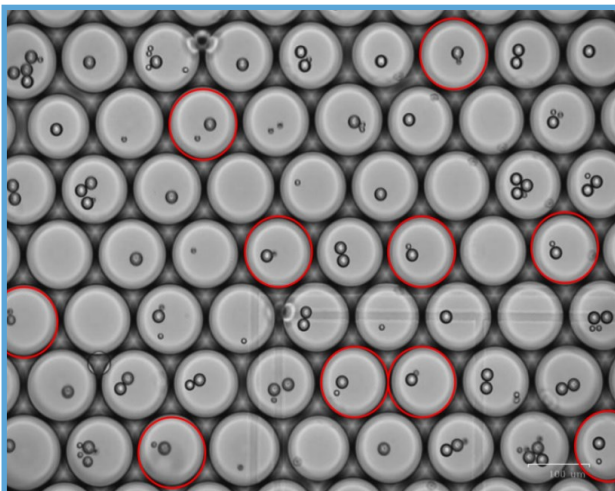

Droplet encapsulation similarly follows the Poisson distribution for a Drop-Seq model. Encapsulation was done with 10 and 20 μm polystyrene beads in 100 μm droplets, where 10 μm beads modeled cells and 20 μm beads modeled barcoding microparticles. Approx. 14.4% of droplets contained one of each bead (vs. 13.5% modeled by the Poisson distribution.)

Working Principle

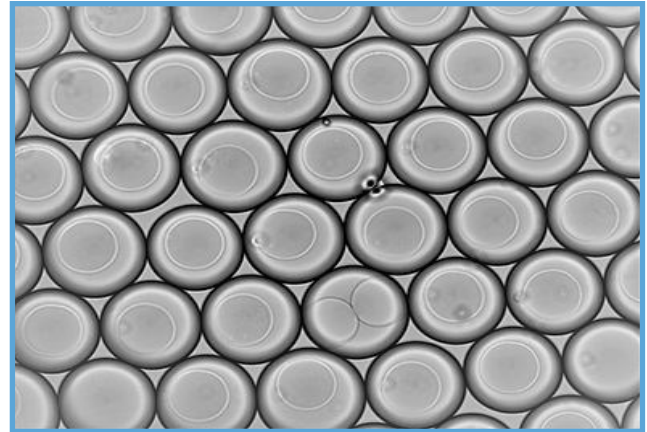
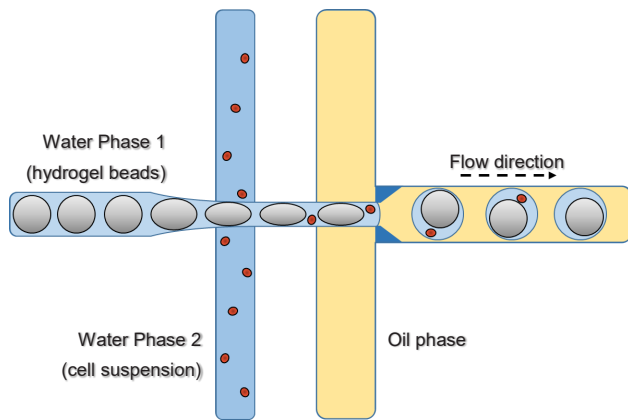

With specially designed microfluidic channels in the same schematic microfluidic chip as in the previous Drop-Seq example, hydrogel beads can reach 90% hydrogel encapsulation rate on our single cell analysis R&D platform.

By attaching functional groups, hydrogel beads have diverse applications, such as cell culture, drug delivery study, etc. Combining mono-dispersed hydrogel beads with different attachments and microfluidic droplet technology allows a high encapsulation rate of single cell and single bead. Suitable droplets can thus be miniature independent reaction chambers. Researchers can study individual cell behaviors with different environments. By adding barcodes on hydrogel beads, single cell RNA seq can be achieved. Researchers are able to study rare cancer cell mutation, response to new drugs, and CRISPR screening, etc. Using this platform, cell isolation and sorting can be achieved as well.

System Diagram

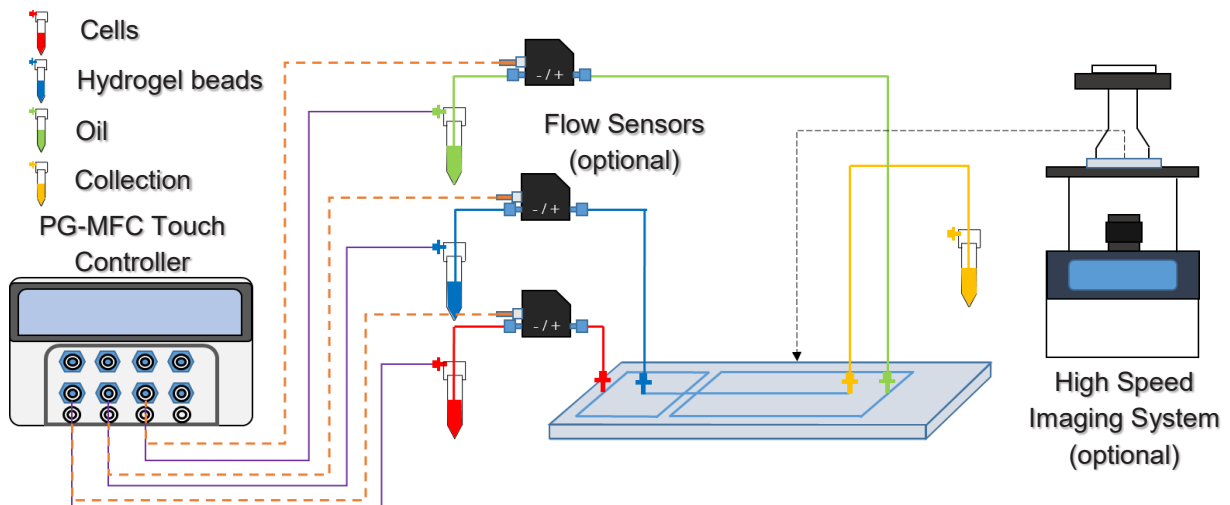

Email: USSales@precigenome.com
Tel: +1-408-708-4602

Address: 2176 Ringwood Ave., San Jose, CA, USA
Visit us at www.precigenome.com/microfluidic-droplet-generator



PreciGenome is located in the heart of Silicon Valley, San Jose, California, USA. We have been focusing on developing nanoparticle synthesis systems and solutions for our customers since we started our business. Our technology enables rapid prototyping with high quality and reliable performance for lipid nanoparticles, liposomes, PLGA, etc.

HEADQUARTER

PreciGenome LLC

Tel: 1-408-708-4602

Email: USSales@precigenome.com

Address: 2176 Ringwood Ave. San Jose, California, USA

TAIWAN DISTRIBUTOR

Ding Fong Scientific Co., Ltd

Tel: 886-4-23595717

Email: ding-fong@ding-fong.com.tw

CHINA DISTRIBUTOR

Suzhou Rainsure Biotech Co. Ltd

Tel: 86-512-67503398

Email: info@rainsurebio.com

KOREA DISTRIBUTOR

InSung Chroma-Tech Co., Ltd.

Tel: 82-226441991

Email: KRSales@precigenome.com

